

# FIREMAGIC®

## DOUBLE SIDEBURNER

DIAMOND SERIES

32814 Series

### INSTALLATION AND OPERATING INSTRUCTIONS

**INSTALLER:** Leave these instructions with consumer.

**CONSUMER:** Retain for future reference.



**Important:** READ THESE INSTRUCTIONS CAREFULLY BEFORE STARTING INSTALLATION

### WARNINGS AND SAFETY CODES

#### **⚠ DANGER:**

##### **IF YOU SMELL GAS:**

1. Shut off the gas to the appliance.
2. Extinguish any open flame.
3. Open lid.
4. If odor continues, keep away from the appliance and **immediately** call your gas supplier or the fire department.

**CODE AND SUPPLY REQUIREMENTS:** This appliance must be installed in accordance with local codes and ordinances, or, in the absence of local codes, with the latest *National Fuel Gas Code (ANSI Z223.1/NFPA 54)*, or *Natural Gas and Propane Storage and Handling Installation Code (CSA-B149.1)*.

This appliance and its dedicated manual shutoff valve must be disconnected from the gas-supply piping system when testing the system at pressures in excess of ½ psig (3.5 kPa).

This appliance must be isolated from the gas-supply piping system by closing its dedicated manual shutoff valve during any pressure testing of the gas-supply system at pressures up to and including ½ psig (3.5 kPa).

**Proper operation of your appliance requires prompt and periodic maintenance. See the CARE & CLEANING section for details.**

#### **⚠ WARNING:**

1. Do not store or use gasoline or other flammable vapors and liquids in the vicinity of this or any other appliance.
2. An LP cylinder not connected for use shall not be stored in the vicinity of this or any other appliance.

#### **⚠ WARNING:**

Improper installation, adjustment, alteration, service, or maintenance can cause injury or property damage. For proper installation, refer to the installation instructions. For assistance or additional information, consult a qualified professional installer, service agency, or the gas supplier.

All electrical outlets in the vicinity of the appliance must be properly grounded in accordance with local codes, or, in the absence of local codes, with the *National Electrical Code, ANSI/NFPA 70*, or the *Canadian Electrical Code, CSA C22.1*, whichever is applicable.

Keep all electrical-supply cords and fuel-supply hoses away from any heated surface.



09-41

Certified to: ANSI Z21.58b-2012  
CSA 1.6b-2012

Robert H. Peterson Co. • 14724 East Proctor Avenue • City of Industry, CA 91746

# INSTALLATION INSTRUCTIONS ET MANUEL DU PROPRIÉTAIRE DANS LE CONTRE- DOUBLE SIDEBURNER

## **⚠ DANGER:**

### **SI VOUS SENTEZ LE GAZ :**

1. Coupez le gaz à l'appareil.
2. Éteignez-vous n'importe quelle flamme nue.
3. Ouvrez le couvercle si équipé d'un four.
4. Si l'odeur continue, gardez loin de l'appareil et appelez immédiatement votre département de fournisseur ou de feu de gaz.

## **⚠ AVERTISSEMENT:**

1. Ne stockez pas ou n'employez pas l'essence ou d'autres vapeurs et liquides inflammables à proximité de ceci ou d'aucun autre appareil.
2. Un cylindre de propane non relié pour l'usage ne sera pas stocké à proximité de ceci ou d'aucun autre appareil.

## **CONDITIONS DE CODE ET D'APPROVISIONNEMENT:**

Ce gril doit être installé selon des codes et des ordonnances locaux, ou, en l'absence des codes locaux, avec l'un ou l'autre le plus défunt *Code national de gaz de carburant* (norme ANSI Z223.1/NFPA 54), et *Stockage de gaz naturel et de propane et manipulation du code d'installation* (CSA-B149.1).

Cet appareil et ses différents robinets d'isolement doivent être démontés du gaz-fournissent le système sifflant en examinant le système aux pressions au-dessus du ½ psig (kPa 3.5).

Cet appareil doit être isolé dans gaz-fournissent le système sifflant par fermeture que ses différents robinets d'isolement manuels pendant tous les essais sous pression du gaz-fournissent le système aux pressions jusques et y compris le ½ psig (kPa 3.5).

- Ce gril est pour utilisation à l'extérieur seulement. Si l'appareil est entreposé à l'intérieur, enlever les bouteilles et les laisser à l'extérieur.
- Ne pas ranger le gril immédiatement après l'avoir utilisé. le laisser refroidir avant de le déplacer ou de la ranger. Le non respect de cette mesure de sécurité pourrait entraîner un incendie causant des dommages à la propriété, des blessures ou la mort.
- Ne pas utiliser cet appareil sous une surface combustible.
- Ne pas utiliser cet appareil sous un auvent. Le non respect de cette mesure de sécurité pourrait entraîner un incendie ou des blessures.
- Dégagement minimal entre les parois latérales et l'arrière de l'appareil et la construction combustible (45.7 cm à partir des parois latérales et 45.7cm à partir de l'arrière).
- Le régulateur de pression de gaz prévu avec cet appareil de cuisson à gaz pour l'extérieur doit être utilisé. Ce régulateur est réglé pour une pression de sortie de 5 pouces de colonne de l'eau pour le gaz naturel, et 10 pouces pour le propane.
- LE RÉGULATEUR INCLUS D'APPAREILS EST ÉVALUÉ POUR LE MAXIMUM DE 1/2 (LIVRES PAR POUCE CARRÉ). SI VOTRE OFFRE DE GAZ EST 1/2 PLUS GRAND QUE (LIVRES PAR POUCE CARRÉ), UN RÉGULATEUR ADDITIONNEL DOIT ÊTRE INSTALLÉ AVANT LE GRIL. VOIR LA SECTION DE CONDITIONS D'OFFRE DE GAZ POUR LA PRESSION APPROPRIÉE D'OFFRE DE GAZ.

## **⚠ AVERTISSEMENT:**

L'installation inexacte, l'ajustement, le changement, le service, ou l'entretien peuvent causer des dommages ou des dégâts matériels. Référez-vous à ce manuel. Pour l'aide ou l'information additionnelle, consultez un installateur professionnel qualifié, l'agence de service, ou le fournisseur de gaz.

Toutes les sorties électriques à proximité du gril doivent être correctement fondues selon des codes locaux, ou en l'absence de local code, avec le code électrique national, ANSI/NFPA 70, ou le code électrique canadien, CSA C22.1, celui qui est applicable.

Maintenez tout électrique-fournissent des cordes et carburant-fournissent des tuyaux partis de n'importe quelle surface de chauffage.

- Ne couvrez jamais la surface entière de cuisine ou de gril de gauffreuses ou de casseroles. La surchauffe se produira et les brûleurs ne seront pas très performants quand la chaleur de combustion est emprisonnée au-dessous de la surface à cuire.
- Ne pulvérisez jamais l'eau sur une unité chaude de gaz, comme ceci peut endommager des composants de porcelaine ou de fer de fonte.
- Une fuite de GPL peut causer un incendie ou une explosion si enflammée entraînant des blessures corporelles graves ou la mort.
- Communiquez avec le fournisseur de GPL pour les réparations ou pour disposer de qules bouteille ou du GPL non utilisé.

**Certifié à la norme: ANSI Z21.58b-2012  
CSA 1.6b-2012**

**INSTALLATEUR : Laissez ces instructions avec le consommateur.  
CONSOMMATEUR : Maintenez pour la future référence.**

## CONTENTS

1	WARNINGS AND SAFETY CODES
4	DOUBLE SIDEBURNER PARTS LIST
5	COUNTERTOP OVERHANG
5	MODEL SPECIFICATIONS
6	COMBUSTIBLE ENCLOSURE CUT-OUT
6	SUBSTRATE
7	DOUBLE SIDEBURNER DIMENSIONS TABLE
7	DOUBLE SIDEBURNER WIRING DIAGRAM
8	ELECTRICAL CONNECTIONS
8	LIGHT SWITCH
8	MAINTENANCE AND SAFETY INFORMATION
9	INSTALLATION REQUIREMENTS
10	ENSURE PROPER COMBUSTION AIR AND COOLING AIRFLOW
10	GAS-SUPPLY PLUMBING REQUIREMENTS
11	NATURAL GAS INSTALLS
11	PROPANE GAS INSTALLS (HOUSEHOLD & CYLINDER)
11	WHEN A PROPANE CYLINDER IS USED
11	ENCLOSURE REQUIREMENTS
12	COUNTER PREPARATION
12	CONNECT THE GAS SUPPLY
12	INSTALLATION
13	CONNECT TO A POWER SOURCE
14	POWER SUPPLY (MULTIPLE ACCESSORY UNITS)
15	SLIDE UNIT INTO ENCLOSURE
15	POSITION THE BURNER CAPS
15	ELECTRICAL SAFETY
16	CONVERTING THE GAS TYPE
17	AIR SHUTTER ADJUSTMENT
19	SAFE USE & MAINTENANCE OF PROPANE GAS CYLINDERS
21	LIGHTING (IGNITION) INSTRUCTIONS
21	SHUTTING OFF THE UNIT
22	CARE & CLEANING
23	CHECKING AND CONVERTING THE REGULATOR
23	CHECKING AND CONVERTING GAS TYPE
24	CONTROL PANEL REMOVAL
25	TROUBLESHOOTING
26	WARRANTY

# DOUBLE SIDEBURNER PARTS LIST

Item	Description	Part No.	Qty.
1.	Double sideburner cover	3281-07	1
2.	Porcelain cast iron cooking grid	3529	1
or	Stainless steel cooking grid	3529-S	1
3.	Burner assembly (w/ burner pipe)	3279-32	2
4.	Control panel	23281-09	1
5.	Valve manifold assembly	3281-22	1
6.	Ignitor assembly	3199-72	2
7.	Control knob	24182-42	2
8.	Lighted bezel assembly	24182-44	2
9.	Convertible Regulator	PR-4	1
10.	Natural gas orifice ‡	3001-51-1	2
or	Propane gas orifice ‡	3001-58-1	2
11.	Wire harness assembly ‡	24182-52	1
12.	Wire harness extension ‡	23278-12	1
13.	Light switch	24182-46	1
14.	Flex connector w/ fittings ‡	3036	1
15.	Power supply w/ connector * ‡	24187-18	1

‡ Not shown

\* Optional / purchased separately

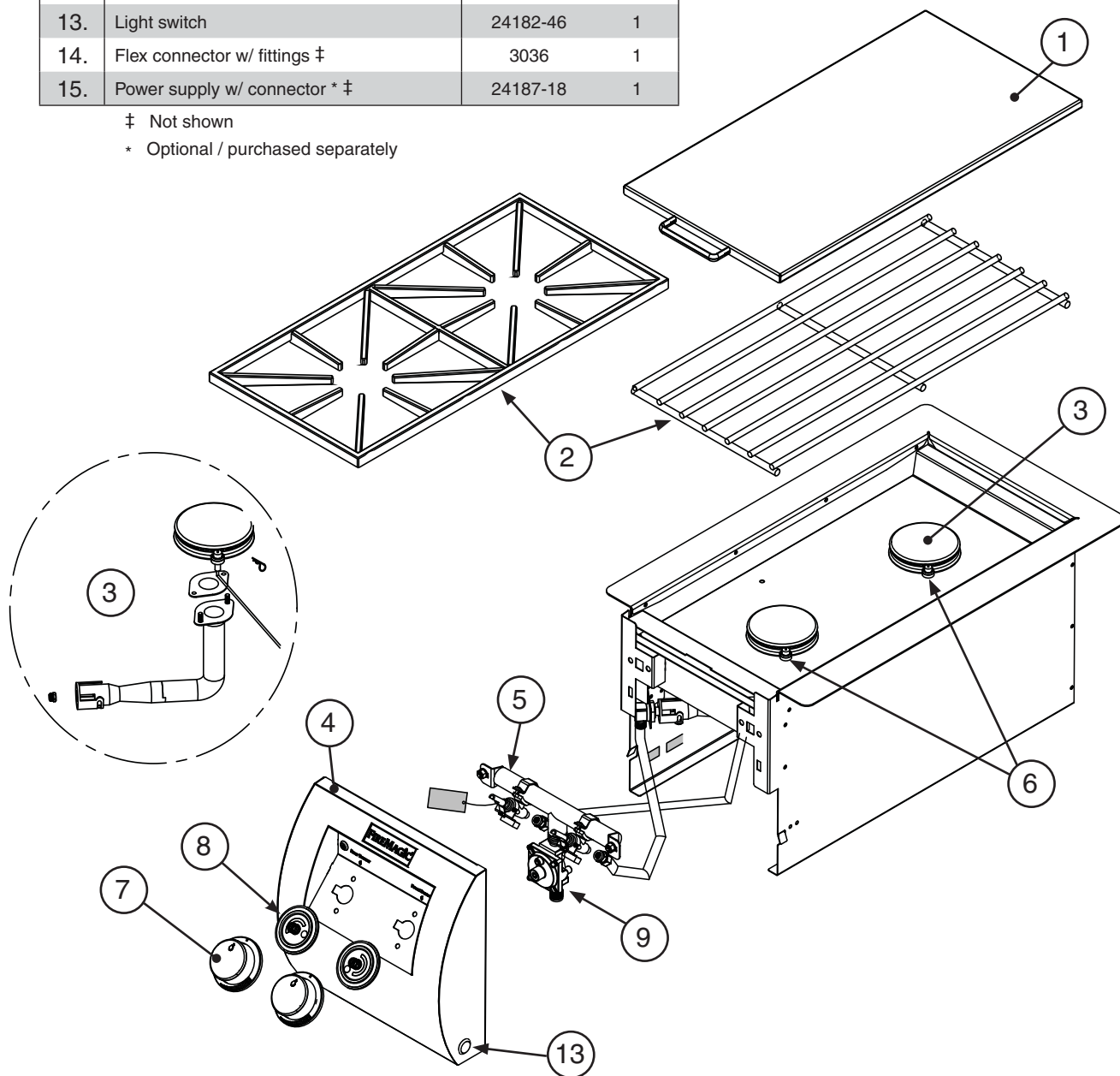

# MODEL SPECIFICATIONS

## MODEL SPECIFICATIONS TABLE

Table 1	
Main burner quantity	2
N/P orifice drill size	#51 / #58
Input electrical requirements	120VAC / 15 AMP minimum / 60 Hz / GFCI outlet

	Non-combustible enclosures	Combustible enclosures
<b>A</b> Countertop to unit bottom <b>cut-out</b>	12"	12"
<b>B</b> Side to side <b>cut-out</b>	11-1/2"	12"▲
<b>C</b> Front to back <b>cut-out</b> †	22-3/4"	23-1/4"▲
<b>D</b> Control panel width <b>cut-out</b> ‡	12-5/8"	12-5/8"

▲ The increased dimensions for combustible enclosures allow for a required air gap along the sides and rear of the unit. See the **COMBUSTIBLE ENCLOSURE CUT-OUT** section on the next page for details.

† Includes any substrate at front wall of enclosure (in the area the rear of the control panel is to sit flush against). See **SUBSTRATE** section on next page.

‡ Only applicable for enclosures that have countertops with an overhang (see illustration and section below).

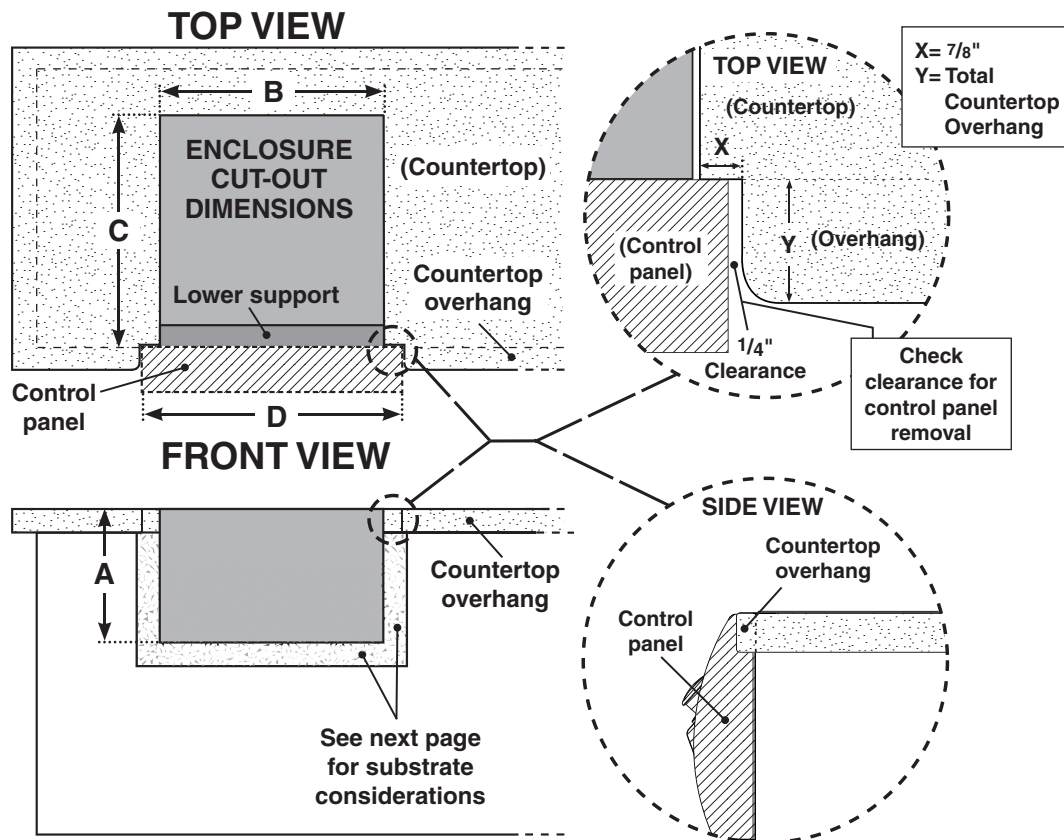

Fig. 5-1

## COUNTERTOP OVERHANG

The control panel is designed to sit flush against the enclosure front wall. If the enclosure countertop extends beyond the front wall, creating a countertop overhang, it must be cut flush with the front wall for the width of the control panel or a gap will be created exposing the forward portions of the left and right side fire walls of the unit. See illustrations above.

**Important:** FOR YOUR SAFETY, you must provide openings in the island enclosure for drainage, replacement air, and cross-ventilation of any storage area exposed to possible leakage from gas connections, the unit, or propane tanks. See the **ENCLOSURE REQUIREMENTS** section for details.

**COMBUSTIBLE ENCLOSURE CUT-OUT**

This unit may be installed into combustible framing (wood, for instance) provided there is a minimum of a 1/2" airspace between ALL sides of the unit and any combustible material.

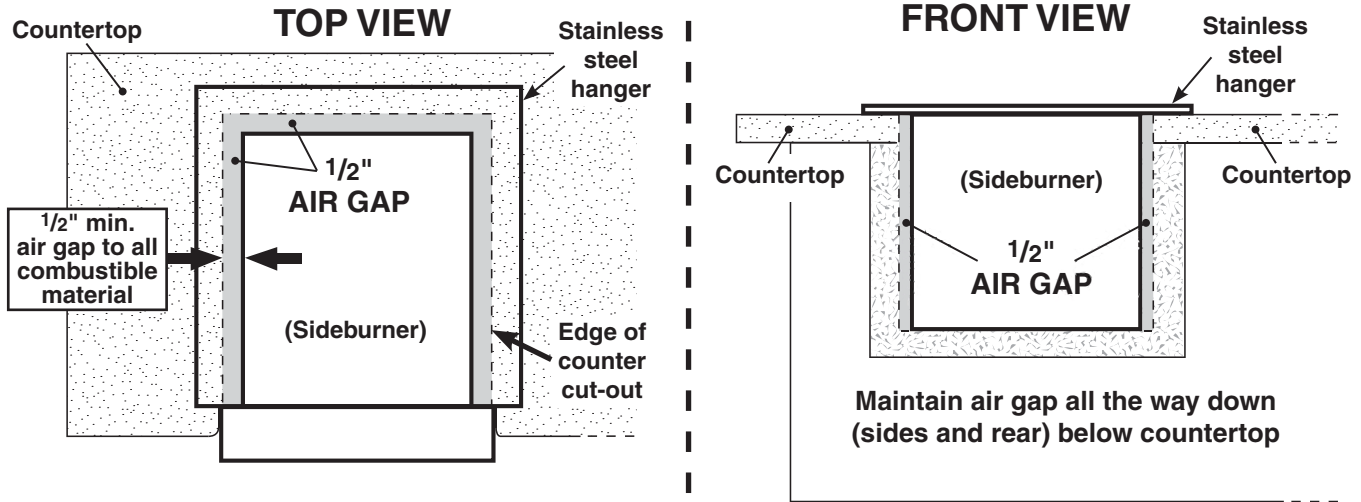

Fig. 6-1

**SUBSTRATE**

When adding any substrate to the enclosure front wall (including tiles, stone, etc.), consider the following:

**Substrate Behind Control Panel**

Substrate + countertop "front to back" cutout must equate to **Dim. C** (see previous page) when the substrate sits flush behind the control panel.

**Substrate Alongside Control Panel**

Any additional substrate alongside the control panel does not need to be considered in **Dim. C** (see previous page), however a 1/4" clearance on each side (same as overhang) and below is required.

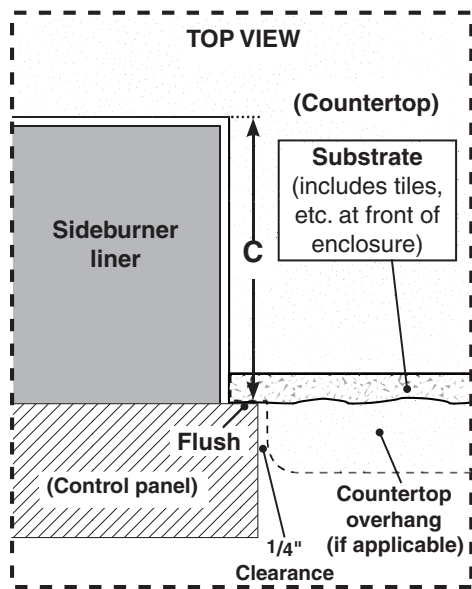

Fig. 6-2

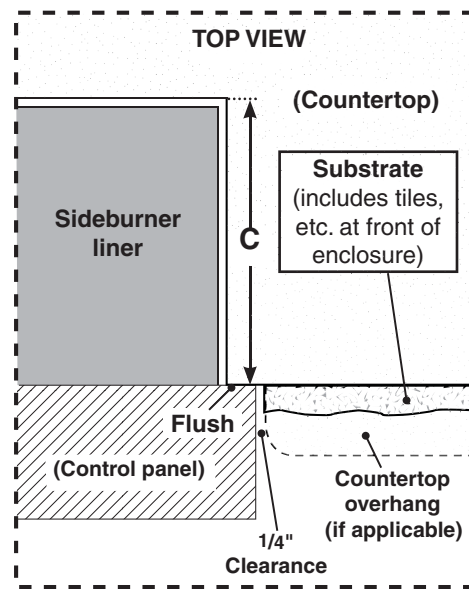

Fig. 6-3



# MODEL SPECIFICATIONS (cont.)

## DOUBLE SIDEBURNER DIMENSIONS TABLE

Height (Top to bottom)	Width (Left to right)		Depth (Front to back)
Top of hanger to bottom of unit <b>(E)</b>	Hanger to hanger <b>(F)</b>	Control panel width <b>(G)</b>	Maximum depth <b>(H)</b>
12"	15 1/2"	12 1/8"	29"

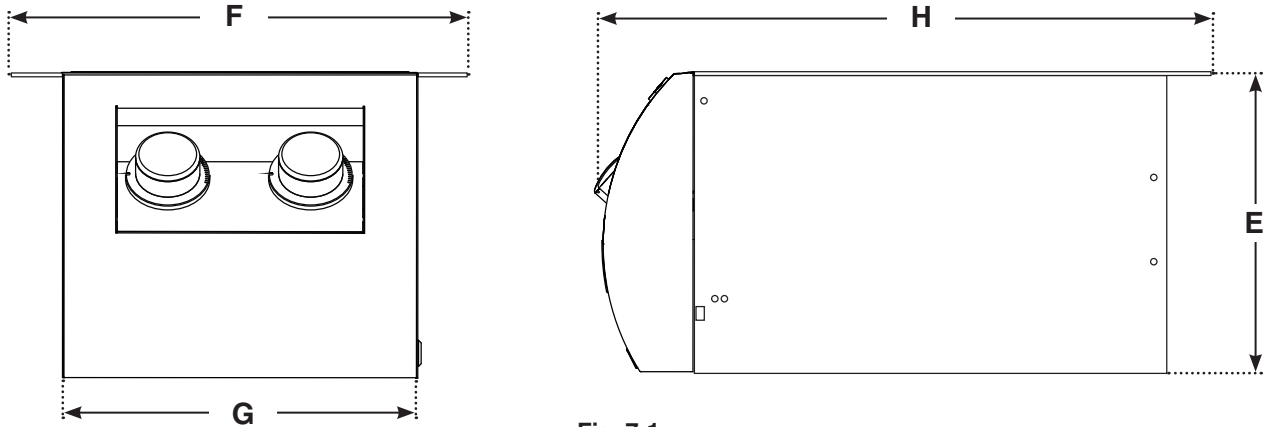
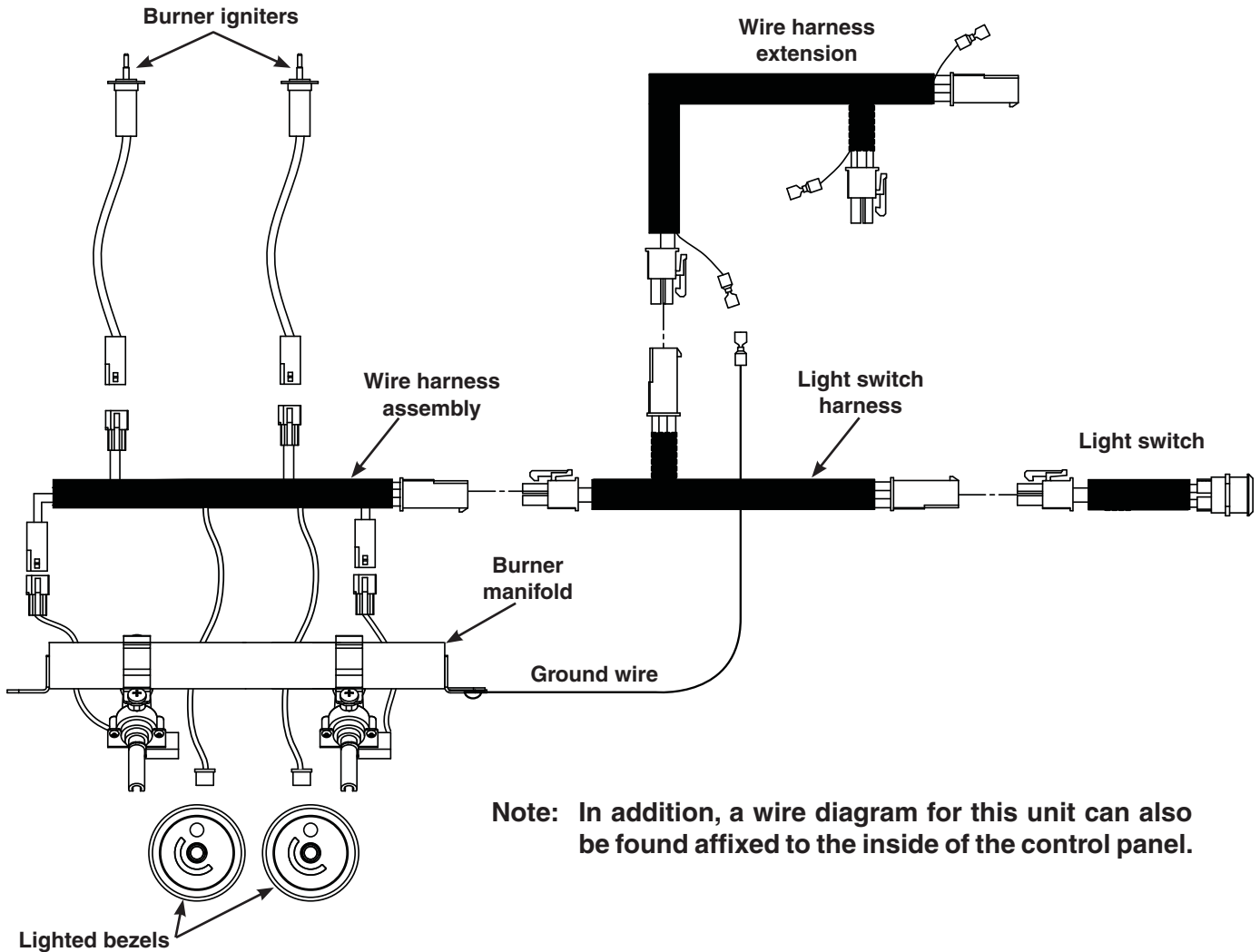

Fig. 7-1

## DOUBLE SIDEBURNER WIRING DIAGRAM



**Note:** In addition, a wire diagram for this unit can also be found affixed to the inside of the control panel.

## MAINTENANCE AND SAFETY INFORMATION

1. The sideburner and surrounding area **MUST** remain clear of flammable substances such as gasoline, yard debris, wood, etc.
2. The airflow through the vent space located below the control panel must remain unobstructed.
3. When using propane gas:
  - a. **The required ventilation openings in the enclosure must be clear of debris.**
  - b. **The propane cylinder, regulator, and rubber hose must be in a location not subject to temperature above 125° F (51° C).**
4. The flames on each burner burn evenly along the burner caps with a steady flame (mostly blue). If burner flames are not normal, check and clean the orifice and burner/venturi tubes for insects and insect nests. A clogged tube can lead to a fire beneath the unit. A proper flame pattern will ensure safe operation and optimal performance. Adjust the air shutter as needed (see AIR SHUTTER ADJUSTMENT).
5. The in-line gas valve or gas cylinder valve must always be shut OFF when the unit is not in use.
6. **Do not operate the burner with the cover in place.**
7. Whenever reconnecting any wires, apply a small amount of dielectric grease to the male connector, then make the connection.

**WARNING: NEVER cover more than 75% of the cooking surface with griddles or pans. Overheating will occur, and burners will not perform properly when combustion heat is trapped below the cooking surface.**

**CAUTION: NEVER spray water on a hot gas unit.**

The unit serial identification number and rating label are located on the inside of the control panel. The unit must be completely cool before opening.

### ELECTRICAL CONNECTIONS

A 120VAC (15 AMP minimum) Ground Fault Circuit Interrupter (GFCI) GROUNDED 3-wire receptacle (not included) is required within the vicinity of the grill to provide power to the unit.

- Observe all local codes.
- **Verify proper polarity of the receptacle.**
- **If an extension cord is used, ensure it is a 3-wire GROUNDED cord that is rated for the power of the equipment, and is approved for outdoor use with a W-A marking. DO NOT use 2-prong adapters.**
- **DO NOT TAMPER WITH THE EXTENSION CORD OR THE UNIT POWER-SUPPLY CORD.**

### LIGHT SWITCH

The light switch is push button operated, and is located on the right side of the control panel (see Fig. 8-1). It controls the power to the lighted knobs and igniters. It allows the power to be turned on or off for safety and convenience. The switch will need to be turned on prior to each use, and turned off after each use.

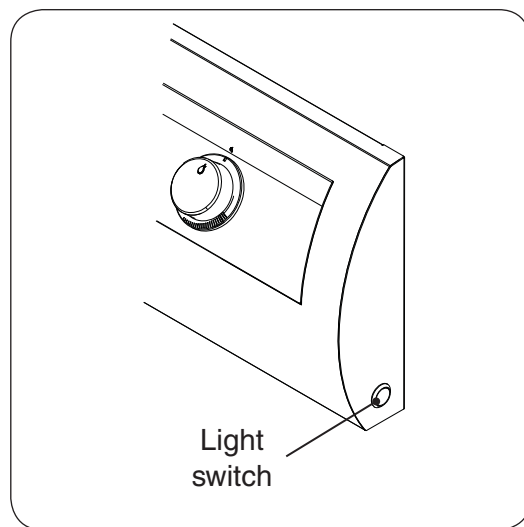

Fig. 8-1



# INSTALLATION REQUIREMENTS

Installation must be performed by a qualified professional service technician.

This unit is designed for outdoor use only. **DO NOT** use this unit inside a building, garage, or enclosed area.

**See below for details on installing under overhead construction.**

**DO NOT** use this unit in or on a recreational vehicle or boat.

**Important:** If installing this unit in a combustible enclosure, the correct air gap requirement must be met.

**Important:** Refer to the information below to ensure all required clearances are met.

**The unit must have a minimum clearance of 18" from combustible materials/items AT ALL TIMES.**

## Overhead Construction Requirements (if applicable)

A 6 foot clearance is required between the countertop and the construction above (Fig. 9-1).

## Side and Rear Wall Clearances

For the minimum clearances between the sideburner and any side or rear walls, your setup must fall within one (or more) of the following:

### A. Clearance between sideburner and strictly non-combustible wall

(i.e. brick wall, see Fig. 9-2)

- The unit must have a minimum of 4" right, left, and rear clearance from any non-combustible wall. (To allow for proper ventilation and prevent dangerous overheating.)

### B. Clearance between sideburner and a protected combustible wall

(i.e. a non-combustible wall in front of a combustible wall to serve as a barrier. This can be accomplished by brick, or a metal stud finished with non-combustible substrate, see Fig. 9-3)

- The unit must have a minimum of 14" right, left, and rear clearance from the protected combustible wall. (The 4" non-combustible material plus an additional 10" clearance between the sideburner and protected wall.)

### C. Clearance between sideburner and combustible wall

- The unit must have a minimum of 18" right, left, and rear clearance from any combustible wall (see Fig. 9-4).

## Backsplash (if applicable)

If a non-combustible backsplash exists, it must have a minimum of a 4" clearance from the rear of the unit (to allow for proper ventilation and prevent dangerous overheating). See Fig. 9-5.

**Important:** This 4" backsplash clearance must first be met prior to any non-combustible walls beginning behind it.

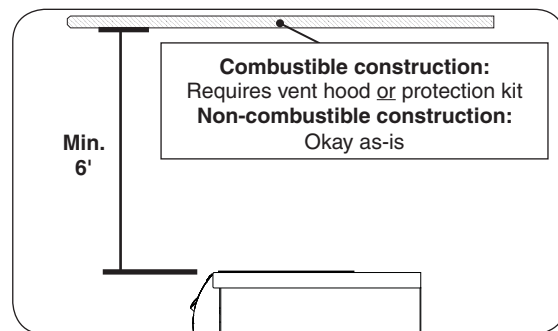

Fig. 9-1 Overhead requirements

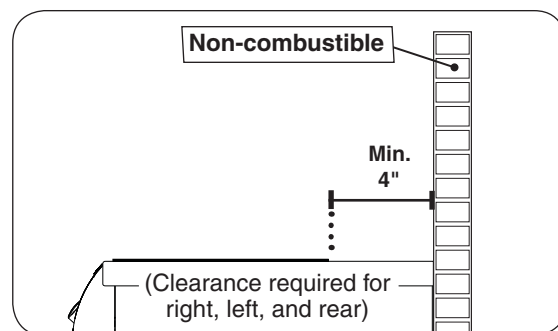

Fig. 9-2 Clearance 'A' Diagram

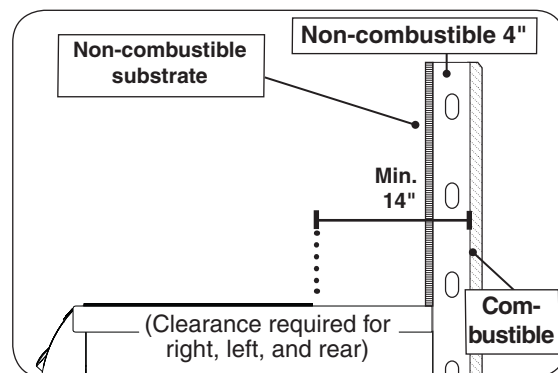

Fig. 9-3 Clearance 'B' Diagram

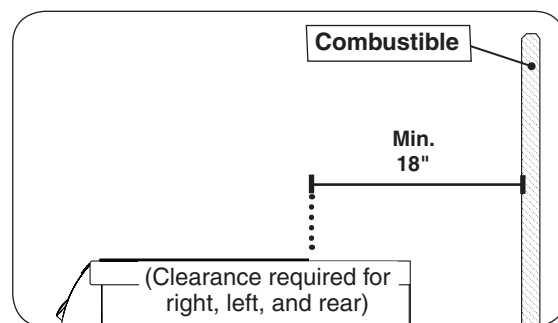

Fig. 9-4 Clearance 'C' Diagram

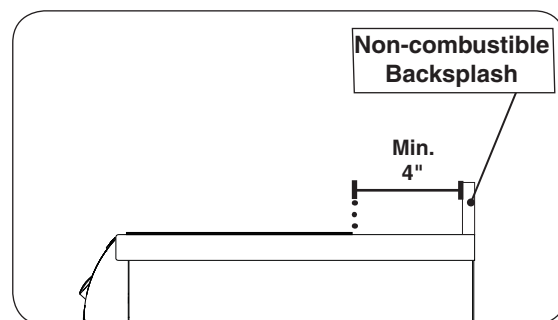

Fig. 9-5 Backsplash clearance

## INSTALLATION REQUIREMENTS (cont.)

The control panel **MUST** remain removable for servicing (see PARTS LIST).

**THIS UNIT MUST NOT BE LOCATED IN A FULLY ENCLOSED AREA OF ANY KIND.**

### ENSURE PROPER COMBUSTION AIR AND COOLING AIRFLOW

Proper airflow (Fig. 10-1) **MUST** be maintained for the sideburner to perform as it was designed. If airflow is blocked, overheating and poor combustion will result. Do not block the 1" front air inlet along the bottom of the control panel or more than 75% of the cooking grid surface with pans or griddles.

### GAS-SUPPLY PLUMBING REQUIREMENTS

For natural gas or a household propane system, rigid  $\frac{1}{2}$ " or  $\frac{3}{4}$ " black steel pipe or local code-approved pipe is required to conduct the gas supply to the unit. Contact your local gas supplier. Connect this pipe to a required C.S.A.-approved stainless-steel flex connector (attached). An NPT adapter has been provided for  $\frac{1}{2}$ " pipe. **DO NOT use a rubber hose within the unit enclosure.** Apply only joint compounds that are resistant to all gasses to all male pipe fittings except flare fittings. Make sure to tighten every joint securely.

**Note:** If  $\frac{1}{2}$ " pipe is used with **natural gas**, it should be no longer than 20'.

**Important:** An external valve (with a removable key) in the gas line is necessary for safety when the unit is not in use. It also provides for convenient maintenance.

### GAS SUPPLY AND MANIFOLD PRESSURES:

For **natural gas** - normal 7" (17.78 cm) water column (w.c.), minimum 5" (12.7 cm), maximum 10  $\frac{1}{2}$ " (26.7 cm). For **propane gas** - normal 11" w.c., minimum 10" (25.4 cm), maximum 13" (33 cm).

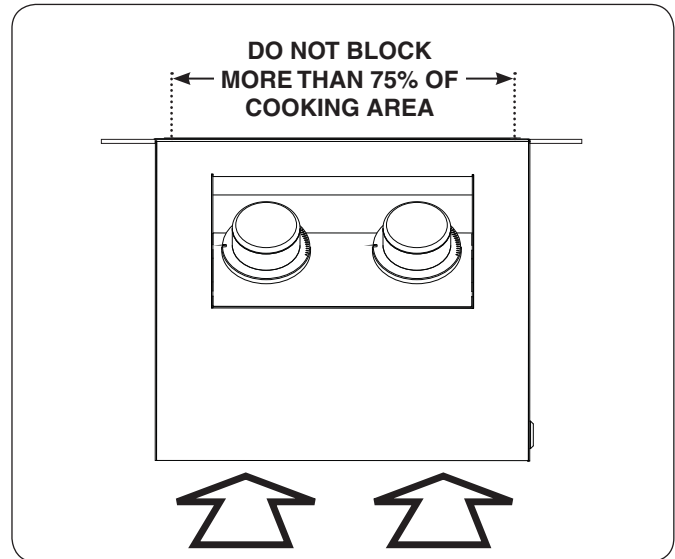

Fig. 10-1 Ventilation Diagram

## ENCLOSURE REQUIREMENTS

FOR YOUR SAFETY, you must provide the openings listed below for drainage, replacement air, and cross-ventilation of any storage area exposed to possible leakage from gas connections, the unit, or propane cylinders.

One side of the enclosure can be left completely open to the outside, OR 4 ventilation openings must be created:

### NATURAL GAS INSTALLS

Two of the openings are to be at the top level (approx. 4" below the countertop) and on opposite walls of the enclosure. 2 more openings must be at the floor level (no more than 5" above the floor) and on opposite sides of the enclosure. Each opening must have a minimum of 10 sq. in. of free area. To achieve the proper ventilation, you may drill a series of holes, omit the grout from masonry joints, or replace a brick with a hardware cloth screen. If the floor in the cabinet is raised and the space beneath the cabinet is open to the outside, the lower ventilation openings may be in the floor. Reference Fig. 11-1.

### PROPANE GAS INSTALLS (HOUSEHOLD & CYLINDER)

Two of the openings are to be at the cylinder valve level (approx. 16" above the floor) and on opposite walls of the enclosure. 2 more openings must be at the floor level (no more than 5" above the floor) and on opposite sides of the enclosure. Each opening must have a minimum of 10 sq. in. of free area. To achieve the proper ventilation, you may drill a series of holes, omit the grout from masonry joints, or replace a brick with a hardware cloth screen. If the floor in the cabinet is raised and the space beneath the cabinet is open to the outside, the lower ventilation openings may be in the floor. Reference Fig. 11-1.

### WHEN A PROPANE CYLINDER IS USED

When a propane cylinder is installed inside of the enclosure, the guidelines below **MUST** be followed. FAILURE TO DO SO MAY CAUSE DAMAGE TO YOUR UNIT AND/OR PERSONAL INJURY. Reference Fig. 11-2 for an example.

- Only a C.S.A. listed stainless steel connector can be connected to the unit.
- The regulator/hose assembly coming from the propane cylinder can only be connected to the above mentioned flex connector. **DO NOT connect the regulator/hose assembly directly to the unit.** An adapter will be required.
- A heatshield must be installed to protect the regulator/hose assembly and propane cylinder valve.
- **RHP offers a propane cylinder door with tank tray to meet the cylinder install requirements. See Fig. 11-3.**

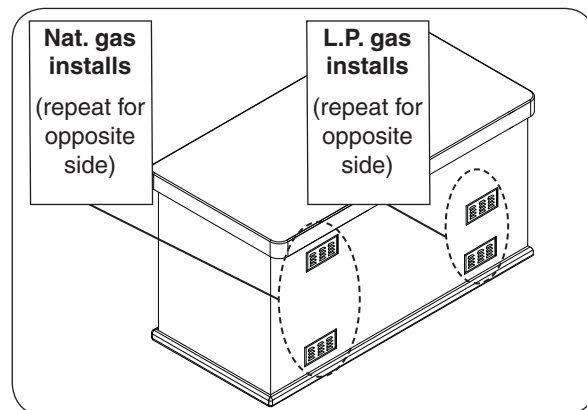

Fig. 11-1 Ventilation detail

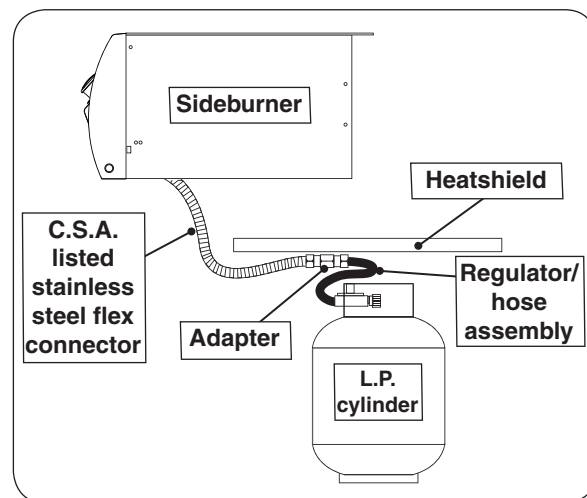

Fig. 11-2 Propane cylinder orientation

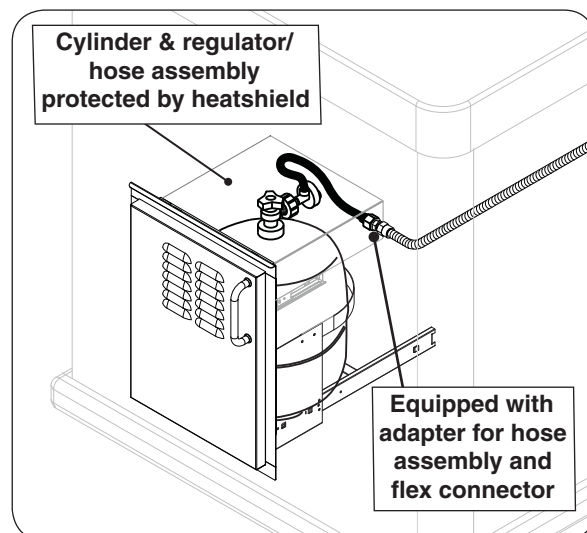

Fig. 11-3 Optional RHP door w/tank tray

## COUNTER PREPARATION

Consult Table 1 for enclosure cut-out dimensions. If the counter or any supporting construction is combustible, the COMBUSTIBLE ENCLOSURE CUT-OUT section must be followed before beginning the installation.

This sideburner must be supported by the stainless-steel hanger extending from the upper portion of the frame. The hanger rests on the left, right, and back of the countertop.

The control panel is designed to sit flush against the enclosure front wall (see Fig. 12-2). If the enclosure countertop extends beyond the front wall, creating a countertop overhang (see Fig. 12-1), it must be cut flush with the front wall for the width of the control panel or a gap will be created exposing the forward portions of the left and right side fire walls of the unit. See the MODEL SPECIFICATIONS section.

**Note:** It is not necessary to remove the control panel or knobs to install this unit.

## CONNECT THE GAS SUPPLY

### For propane cylinders:

For connecting a propane unit to a portable propane tank, read the safety warnings and follow the instructions in the section SAFE USE AND MAINTENANCE OF PROPANE GAS CYLINDERS.

**Note:** When a propane cylinder is installed inside of the enclosure, the guidelines found in the ENCLOSURE REQUIREMENTS section MUST be followed.

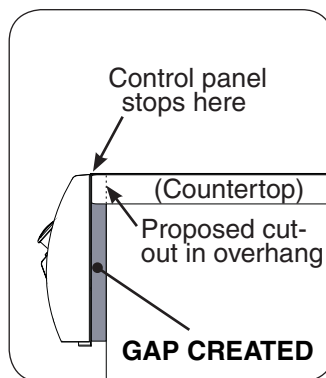

Fig. 12-1

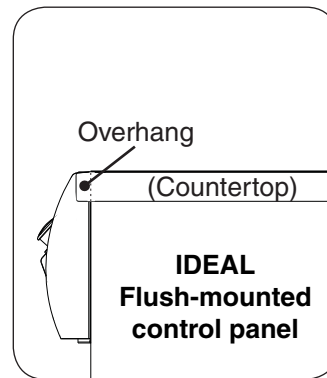

Fig. 12-2

### For household propane or natural gas units:

**CAUTION:** Use only C.S.A. listed stainless-steel flex connectors within the enclosure.

### WARNING

**A rubber or plastic connector will rupture or leak, resulting in an explosion or serious injury if used inside the appliance enclosure.**

1. Locate the attached flex connector (found underneath the unit) and route it to the gas-supply stub.
2. **Turn OFF the gas supply at the source.** Remove the 1/2" adapter that is loosely connected to the flex connector. Attach the adapter to the gas-supply stub using a pipe joint compound that is resistant to all gasses. Tighten securely. Then attach the open end of the flex connector to the adapter. Tighten securely.
3. Turn all burner control knobs to the **OFF** position. Turn the gas supply on. Then carefully check *all* gas connections for leaks with a brush and half-soap/half-water solution before lighting. **NEVER USE A MATCH OR OPEN FLAME TO TEST FOR LEAKS.**
4. Close the dedicated gas-supply shut-off valve.

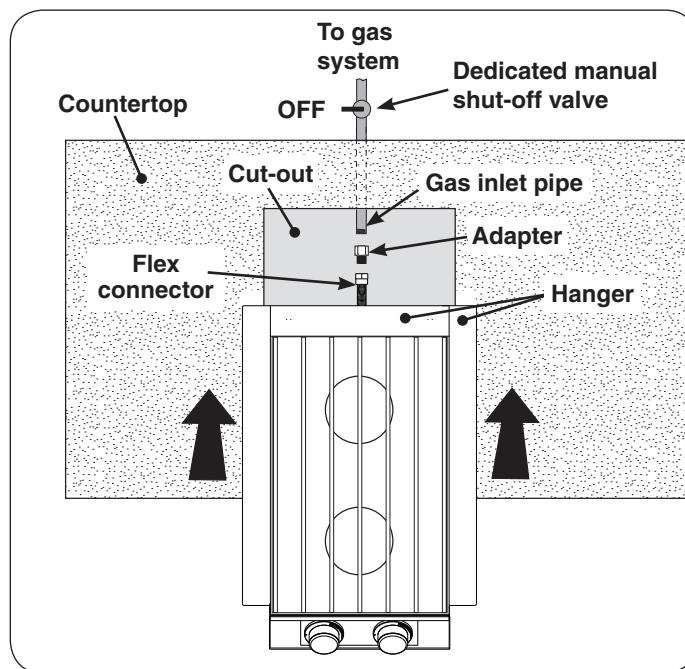

Fig. 12-3 Gas connection diagram

## CONNECT TO A POWER SOURCE

**CAUTION:** Improperly connected wires will cause damage to the unit and may result in property damage and/or personal injury.

The unit comes with a 6' wire extension to retrieve power from a separately purchased Echelon Diamond grill. Echelon Diamond grills are equipped with power supply boxes, which can supply power to the sideburner. Alternatively; an optional power supply box may be ordered and installed to individually power this unit. Contact your dealer for ordering information.

### To install using the wire extension:

1. Locate the power supply box inside of the island enclosure and disconnect the power cord (See Fig. 13-2, **A**).
2. Disconnect the grill wire harness extension connectors from the power supply connectors. See Fig. 13-2, (**B**)
3. Locate the end of the sideburner wire extension that has two molex and ground connections. Connect the extension (plug) molex connection to the power supply (receptacle) molex connection and ground wires (See Fig. 13-3, **C**).
4. Connect the extension (receptacle) molex to the grill (plug) molex connection and ground wires (See Fig. 13-3, **D**).
5. Connect the opposite end of the extension to the sideburner as shown in Fig. 13-3, **E** (molex and ground wire connections).
6. Reconnect the power cord (see Fig. 13-3, **F**).

### Proceed to the **SLIDE UNIT INTO ENCLOSURE** section.

### To install using a power supply box (not included):

1. Install the power supply box at least 12 inches below the bottom of the sideburner.
2. Fasten the power supply box to the inside of the enclosure.
3. Connect the power supply box connectors to the sideburner wire harness extension, as shown in Fig. 13-4, **A** (molex and ground wire connections).
4. Connect the sideburner wire harness extension to the sideburner, as shown in Fig. 13-4, **B** (molex and ground wire connections).
5. Connect the cord coming from the power supply box to a **120VAC (15 AMP minimum) GFCI GROUNDED 3-wire receptacle**. See Fig. 13-4, **C**.

**WARNING: Electrical Grounding Instructions - The power supply box is equipped with a three-pronged (grounding) plug for your protection against shock hazard and should be plugged directly into a properly grounded three-prong receptacle. Do not cut or remove the grounding prong from this plug.**

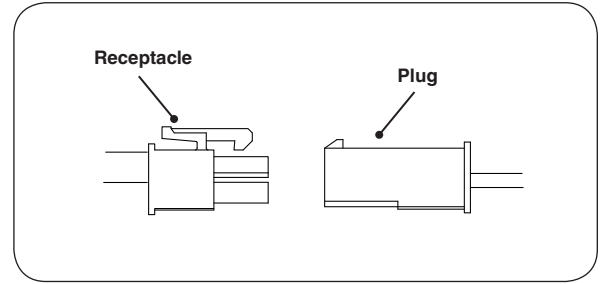

**Fig. 13-1** Connection detail

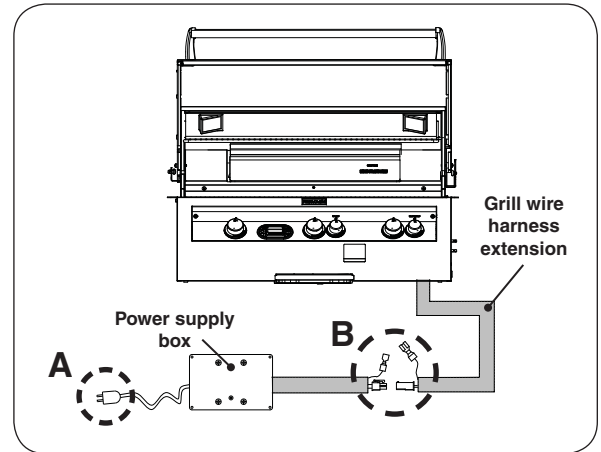

**Fig. 13-2** Disconnect grill connections

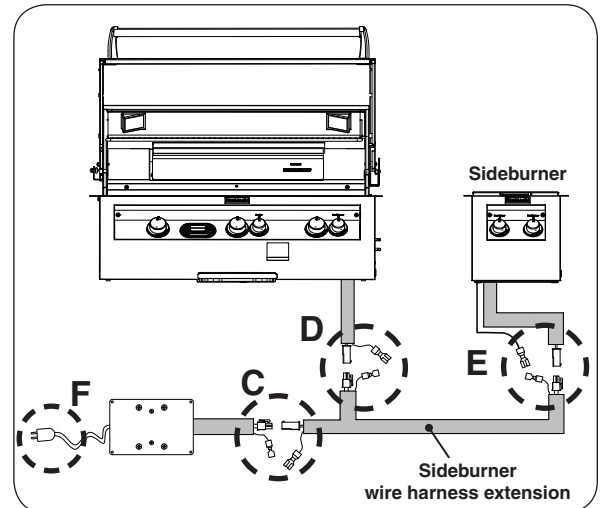

**Fig. 13-3** Connect sideburner to grill setup

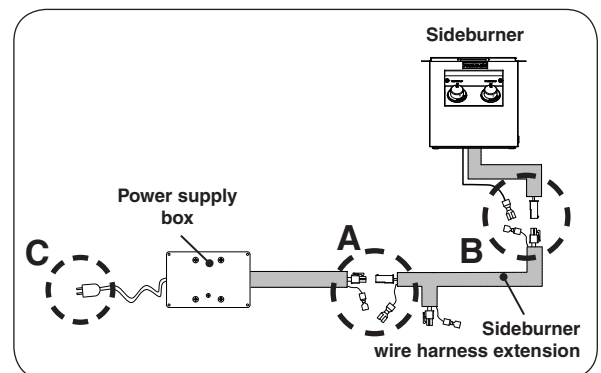

**Fig. 13-4** Connect sideburner to power supply

**POWER SUPPLY (MULTIPLE ACCESSORY UNITS)**

The previous section covers in detail how to individually connect this accessory unit to an Echelon grill power supply box. If multiple accessory units are to be installed, the following diagrams will assist in their installation.

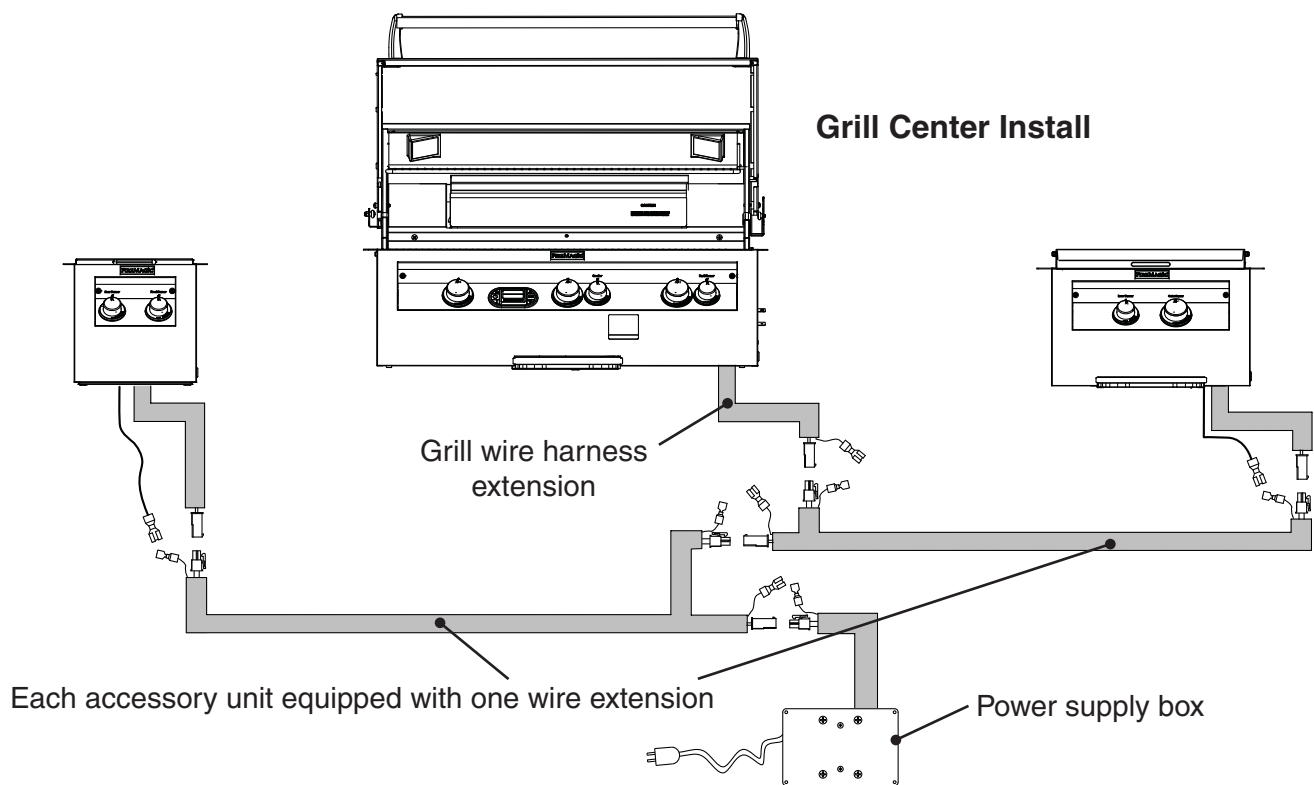
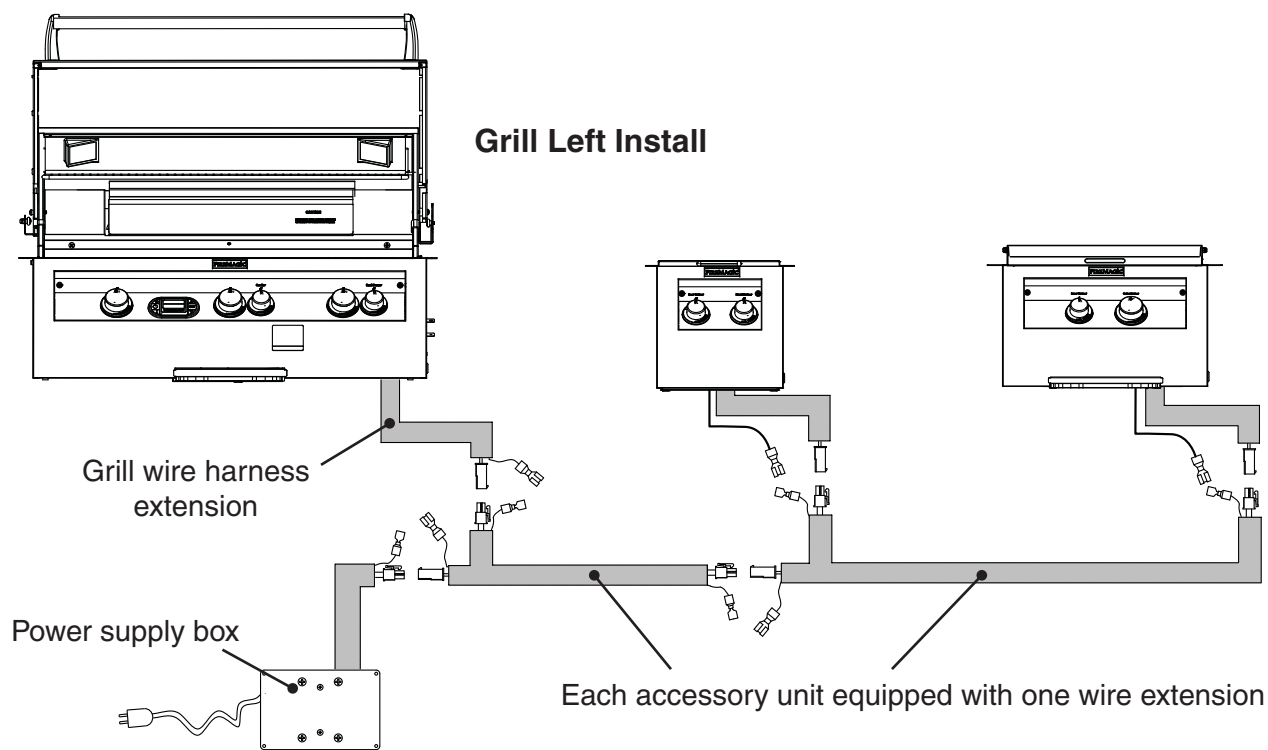



### SLIDE UNIT INTO ENCLOSURE

Slide the unit into place. Do not pinch, kink, or damage the gas connector line.

**Note:** Each side of the unit has a tab just behind the control panel. These tabs prevent the control panel from moving inward. If the tabs interfere with the unit sliding in (see Fig. 15-1), use pliers to bend them inward so that they clear the enclosure sides. Leave the tabs slightly out to ensure they still keep the control panel from moving inward (see Fig. 15-2).

### POSITION THE BURNER CAPS

Place the burner caps so they are centered over each burner. Ensure that they rest securely in place.

### ELECTRICAL SAFETY

To protect against electric shock, do not immerse cord or plugs (if equipped) in water or other liquid.

Unplug from the outlet (if applicable) when not in use and before cleaning. Allow to cool before putting on or taking off parts.

Do not operate any outdoor cooking gas appliance with a damaged cord, plug, or after the appliance malfunctions or has been damaged in any manner. Contact the manufacturer for repair.

Do not let the cord hang over the edge of a table or touch hot surfaces.

Do not use an outdoor cooking gas appliance for purposes other than intended.

When connecting, first connect plug to the outdoor cooking gas appliance then plug appliance into the outlet.

**Use only a properly wired and inspected 120VAC (15 AMP minimum) GFCI GROUNDED 3-wire receptacle with this outdoor cooking gas appliance.**

Never remove the grounding plug or use with an adapter of 2 prongs.

Use only extension cords with a 3 prong grounding plug, rated for the power of the equipment, and approved for outdoor use with a W-A marking.

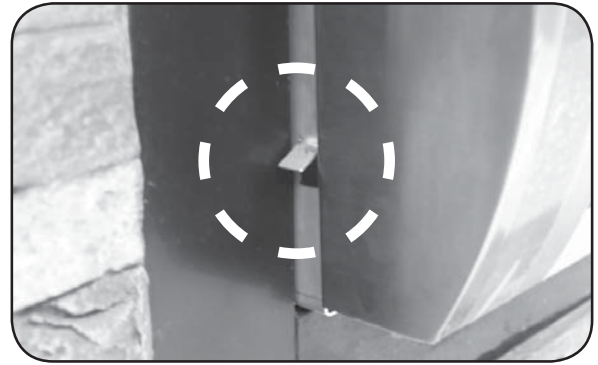

**Fig. 15-1** Tab may interfere when sliding in unit

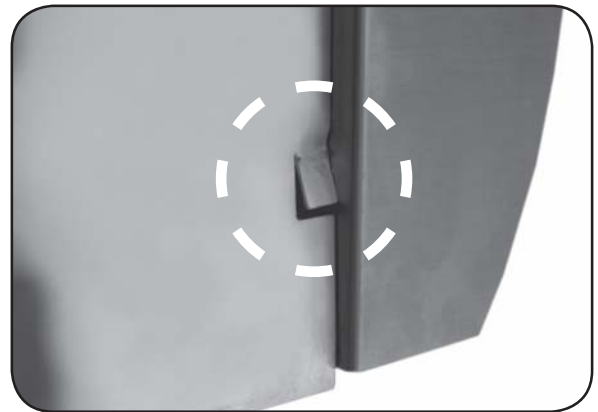

**Fig. 15-2** Tab slightly bent in for clearance

## CONVERTING THE GAS TYPE

Fire Magic units are equipped with orifices for natural gas, unless otherwise indicated. For use with propane gas, smaller orifices must be installed to avoid hazardous overheating. Please refer to Table 1 for the correct orifice size. Check the orifice size by following the instructions below. The drill size is stamped on the orifice. If the number is not visible you may have to remove the orifice (as detailed below) to read the number stamped on the side of the orifice.

**If you are not sure you have the correct sideburner orifice size (or wish to change the orifice), follow the steps below.**

**CAUTION:** If the burner has been in use, wait until the burner and its components are cool to the touch.

**IMPORTANT:** When converting orifices for different gas type, the regulator must also be converted for the new gas type. Reference the CHECKING AND CONVERTING THE REGULATOR section.

1. Turn off the gas shutoff valve. Remove sideburner cover and lift off cooking grid.
2. Remove the control panel. See the CONTROL PANEL REMOVAL section for details.
3. Reach up under the burner support and remove the burner retaining clip (see Fig. 16-1), located at the rear of the burner pipe.
4. Remove the burner cap and carefully lift the burner up and out, clearing the ceramic electrode (see Fig. 16-2), and pulling the burner tube away from the orifice, located on the end of the orifice holder on the left side of the unit (see Fig. 16-3).

**Note:** You do not have to lift the burner completely out of the unit to access the orifice.

5. Using a  $\frac{3}{8}$ " socket, remove orifice from the orifice holder (see Fig. 16-3) and check the number stamped on the orifice face.
6. If an orifice change is necessary, replace the orifice with the correct size.
7. Replace the sideburner tube over the orifice, aligning the burner over the electrode, taking care not to detach it from the wire.
8. Replace the burner retaining clip (underneath burner), and burner cap.
9. Repeat steps 3. through 8. for the second burner.
10. Replace the control panel, bezels, and control knobs.
11. Replace the grid and cover.

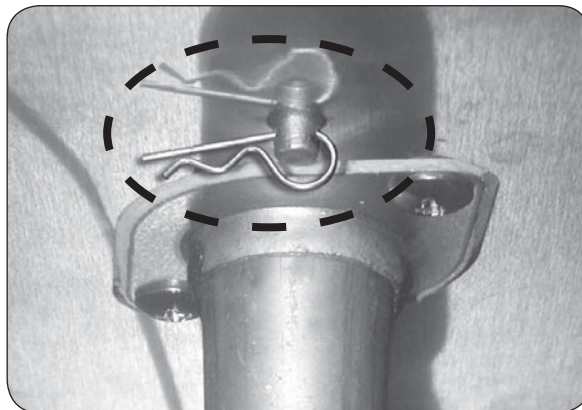

Fig. 16-1 Remove burner clip



Fig. 16-2 Remove burner

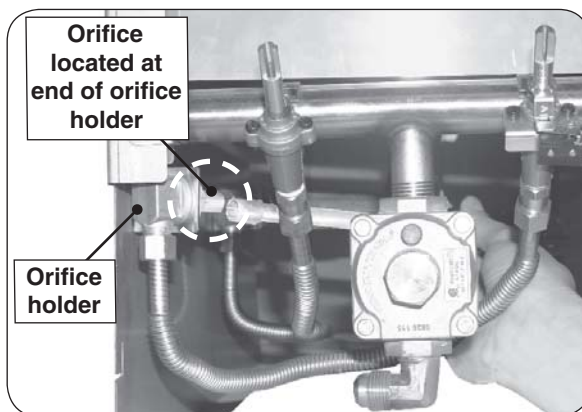

Fig. 16-3 Orifice location

## AIR SHUTTER ADJUSTMENT

Air shutters are preset at the factory based on the gas the sideburner is built to burn. However, altitude or other local conditions may require air shutter adjustment for proper combustion.

The flames from a properly adjusted sideburner will touch the burner ports and appear mostly blue.

If they are orange, “lazy,” or lift off the burner ports, then adjust the sideburner air shutter using the following steps.

The air shutters are located at the end of the burner assemblies, behind the control panel. They can safely and easily be adjusted while the unit is lit.

**CAUTION:** Do not touch the sideburner surrounding top area, as it will be hot while adjusting the air shutter.

1. Remove the control panel. See the CONTROL PANEL REMOVAL section for details.
2. Replace the control knobs back on to the valve stems.
3. Light the sideburner following the LIGHTING INSTRUCTIONS section.
4. Loosen the front burner air shutter adjustment screw, then use the tip of a screwdriver to open or close the air shutter until the flames appear blue and touch the burner ports.
5. Retighten the adjustment screw.
6. Repeat for rear burner air shutter.

**Should you have difficulty accessing the rear burner air shutter, you may shut down, remove the rear burner (when cool), then adjust the air shutter to the same opening as the already adjusted front burner. (See CONVERTING THE GAS TYPE section to remove rear burner.) Be sure to properly reinstall rear burner when complete.**

7. Once all adjustments are complete; be sure the unit is off and remove the knobs, then replace the control panel, bezels, and knobs.

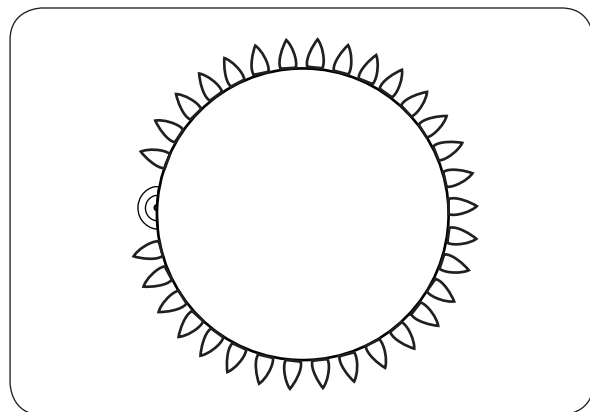

Fig. 17-1 Flame pattern

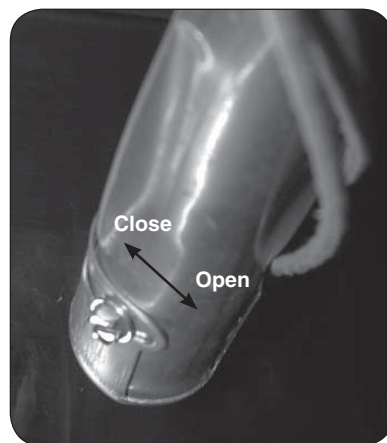

Fig. 17-2 Adjust air shutter

# UTILISATION SÛRE ET ENTRETIEN DES CYLINDRES DE GAZ DE PROPANE

## IMPORTANT POUR VOTRE SÛRETÉ

LISEZ ET SUIVEZ TOUS LES AVERTISSEMENTS ÉQUIPÉS DE VOTRE CYLINDRE DE GAZ DE PROPANE.

En actionnant cet appareil avec un cylindre de gaz de propane ON DOIT observer ces instructions et avertissements.

**LE MANQUE DE FAIRE AINSI PEUT AVOIR COMME CONSÉQUENCE UNE INCENDIE OU UNE EXPLOSION SÉRIEUSE.**

### CYLINDRE ET CONDITIONS ET CARACTÉRISTIQUES DE CONNECTEUR

- Des cylindres et les valves de gaz de propane doivent être maintenus en bon état et doivent être remplacés s'il y a des dommages évidents au cylindre ou à la valve.
- Ce gril, une fois utilisé avec un cylindre, devrait être relié à un gallon de la norme 5 (20lb.) cylindre de gaz de propane équipé d'un OPD (remplissez au-dessus du niveau le dispositif d'empêchement). L'OPD a été exigé sur tous les cylindres vendus depuis octobre 1.1998 pour empêcher le remplissage excessif.
- Les dimensions de cylindre devraient être approximativement 12" (30.5cm) de diamètre et 18" (45.7cm) hauts. Des cylindres doivent être construits et marqués selon les caractéristiques pour des cylindres de gaz de propane du département des ETATS-UNIS du transport (D.O.T.) ou le niveau national du Canada, du CAN/CSA-B339, des cylindres, des sphères et des tubes pour le transport des marchandises dangereuses.
- Le cylindre doit inclure un collier pour protéger la valve de cylindre et le circuit d'alimentation de cylindre doit être assuré le retrait de vapeur.
- Le régulateur de pression et l'ensemble de tuyau utilisé doivent assortir les spécifications pour le type I par ANSI Z 21.58-2005/CGA 1.6-2005 (voir la fig. 18-1).
- La valve de cylindre de gaz de propane doit être équipée d'un dispositif d'accouplement de raccordement de cylindre, décrit comme type I dans la norme définie dans le e. de paragraphe ci-dessus. Ce dispositif est généralement décrit comme coupleur rapide de fil de point culminant.
- Si votre cylindre de gaz de propane vient avec une prise de la poussière, placez le bouchon anti-poussière sur la sortie de valve de cylindre toutes les fois que le cylindre n'est pas en service.

### OPÉRATION DE COUPLEUR RAPIDE

**Pour relier le régulateur/hose à l'ajustage de précision de valve de cylindre de gaz de propane:** Serrez l'écrou de main sur le régulateur au-dessus de l'ajustage de précision de fil de point culminant sur la valve de cylindre. Tournez l'écrou de

main dans le sens des aiguilles d'une montre pour engager les fils et pour serrer jusqu'à ce que douillettement. L'utilisation des pinces ou de la clé ne devrait pas être nécessaire. Seulement le propane marqué par cylindres doit être employé.

**Pour débrancher:** Tournez l'écrou de main dans le sens contraire des aiguilles d'une montre jusqu'à isolé (fig. 18-1).

**Important:** Avant d'employer le gril, et ensuite chaque fois que le cylindre est enlevé et rattaché, examinez tous les raccordements pour déceler les fuites. Arrêtez les valves de gril et ouvrez la valve principale de cylindre, puis vérifiez les raccordements avec de l'eau savonneux. Réparez toutes les fuites avant d'allumer le gril.

**ATTENTION:** Tournez toujours la valve principale de cylindre de propane au loin après chaque utilisation, et avant de déplacer le gril et le cylindre, ou débrancher l'accouplement. Cette valve doit rester fermée et le cylindre a débranché alors que l'appareil n'est pas en service, quoique l'écoulement de gaz soit arrêté par un dispositif de sûreté quand le coupleur est débranché.

**Inspectez soigneusement** l'ensemble de tuyau chaque fois avant que le gaz soit allumé. Un tuyau fissuré ou effiloché doit être immédiatement remplacé.

Si l'appareil est stocké à l'intérieur, le cylindre doit être disconnected et a enlevé. Des cylindres Disconnected doivent être stockés dehors, hors de la portée des enfants, avec les prises de valve filettées étroitement installées, et ne doivent pas être stockés dans un bâtiment, le garage, ou n'importe quel autre secteur inclus.

### POUR VOTRE SÛRETÉ

- Ne stockez pas un cylindre de gaz disponible de propane dessous ou ne vous approchez pas de cet appareil.
- Ne remplissez jamais cylindre au delà de 80 pour cent de plein.
- SI L'INFORMATION DANS "A" ET "B" N'EST PAS SUIVIE EXACTEMENT, UN FEU CAUSANT LA MORT OU DES DOMMAGES SÉRIEUX PEUT SE PRODUIRE.

**Fig. 18-1 type coupleur rapide de fil de point culminant d'I**

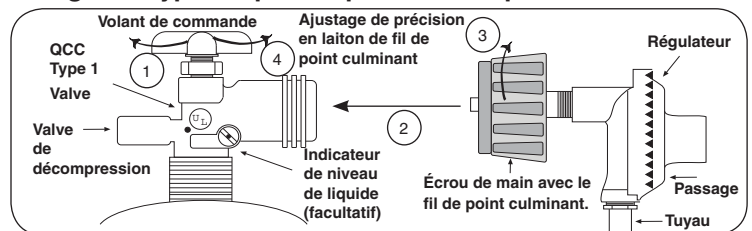

**Pour la ventilation de propane, voir la section sur les exigences de boîtier.**



# SAFE USE & MAINTENANCE OF PROPANE GAS CYLINDERS

## IMPORTANT FOR YOUR SAFETY

### READ AND FOLLOW ALL WARNINGS PROVIDED WITH THE PROPANE-GAS CYLINDER.

When operating this appliance with a propane-gas cylinder, these instructions and warnings **MUST** be observed.

**FAILURE TO DO SO MAY RESULT IN A SERIOUS FIRE OR EXPLOSION.**

## CYLINDER/CONNECTOR REQUIREMENTS

- Propane-gas cylinders, valves, and hoses must be maintained in good condition and must be replaced if there is visible damage to either the cylinder or valve. If the hose is cut or shows excessive abrasion or wear, it must be replaced before using the gas appliance (see e.).
- This unit, when used with a cylinder, should be connected to a standard 5-gallon (20 lb.) propane-gas cylinder equipped with an OPD (Overfill Prevention Device). The OPD has been required on all cylinders sold since October 1, 1998, to prevent overfilling.
- Cylinder dimensions should be approximately 12" (30.5 cm) in diameter and 18" (45.7 cm) high. Cylinders must be constructed and marked in accordance with the *Specifications for Propane Gas Cylinders of the U.S. Department of Transportation (D.O.T.)* or the National Standard of Canada, *CAN/CSA-B339, Cylinders, Spheres, and Tubes for Transportation of Dangerous Goods*.
- The cylinder used must include a collar to protect the cylinder valve, and the cylinder supply system must be arranged for vapor withdrawal.
- The pressure regulator and hose assembly used must match the specification for Type I by *ANSI Z 21.58-2005/CGA 1.6-2005* (see Fig. 19-1).
- The propane-gas cylinder valve must be equipped with a cylinder connection coupling device, described as Type I in the standard defined in paragraph e. above. This device is commonly described as an Acme thread quick coupler.
- If the propane-gas cylinder comes with a dust plug, place the dust cap on the cylinder valve outlet whenever the cylinder is not in use.

## QUICK COUPLER OPERATION

**To connect the regulator/hose assembly to the propane-gas cylinder valve fitting:** Press the hand nut on the regulator over the Acme thread fitting on the cylinder valve. Turn the hand nut clockwise to engage the threads and tighten until snug.

The use of pliers or a wrench should not be necessary. Only cylinders marked "propane" may be used.

**To disconnect:** Turn the hand nut counterclockwise until detached (Fig. 19-1).

**Important:** Before using the unit, and after each time the cylinder is removed and reattached, check the hose for wear (see a.) and check all connections for leaks. Turn off the unit valves and open the main cylinder valve, then check connections with soapy water. Repair any leaks before lighting the unit.

**CAUTION:** Always turn the propane cylinder main valve off after each use, and before moving the unit and cylinder or disconnecting the coupling. This valve must remain closed and the cylinder disconnected while the appliance is not in use, even though the gas flow is stopped by a safety feature when the coupler is disconnected.

**Carefully** inspect the hose assembly each time before the gas is turned on. A cracked or frayed hose must be replaced immediately.

If the appliance is stored indoors, the cylinder must be disconnected and removed. Disconnected cylinders must be stored outdoors, out of the reach of children, with threaded valve plugs tightly installed, and must not be stored in a building, garage, or any other enclosed area.

## FOR YOUR SAFETY

- DO NOT store a spare propane-gas cylinder under or near this appliance.
- NEVER fill the cylinder beyond 80-percent full.
- IF THE INFORMATION IN a. AND b. IS NOT FOLLOWED EXACTLY, A FIRE CAUSING DEATH OR SERIOUS INJURY MAY OCCUR.

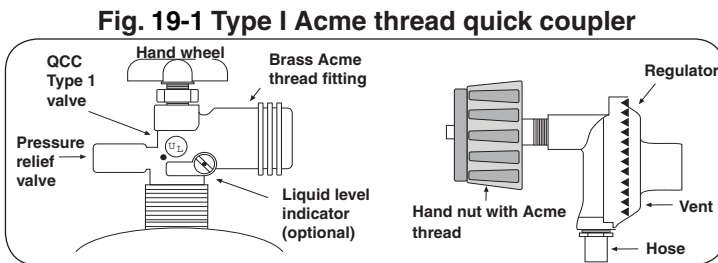

**For propane ventilation requirements, see the ENCLOSURE REQUIREMENTS section.**

# ALLUMAGE DES INSTRUCTIONS (D'ALLUMAGE)

Lisez toutes les instructions avant l'allumage, et suivez ces instructions chaque fois vous lumière le unité.

## ÉCLAIRAGE ÉLECTRONIQUE

**Note:** Le unité doit être relié à la puissance 120VAC pour l'éclairage électronique.

1. Ouvrez les couvercles ou enlevez les couvertures des brûleurs pour être Lit.
2. Tournez tous les boutons de commande de gaz à leurs positions de repos.
3. Allumez le gaz à sa source.

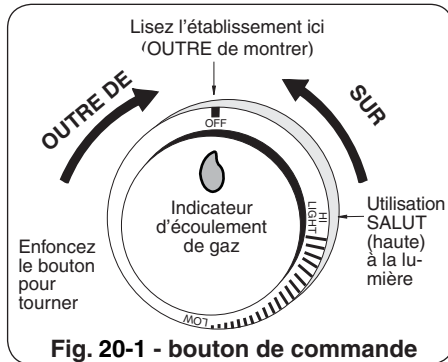

**Note:** N'ouvrez pas plus d'une valve à la fois pour l'éclairage électronique ou manuel.

4. Diminuez le bouton de commande désiré pendant 5 secondes, puis, et tout en pressant le tour il dans le sens contraire des aiguilles d'une montre dans la position LÉGÈRE de HI. Une fois que le brûleur s'allume, libérez le bouton.

**ATTENTION :** Si un brûleur ne s'allume pas dans cinq (5) secondes d'allumer le bouton de commande, enfoncez le bouton et tournez-le à la position de repos. ATTENDEZ CINQ (5) MINUTES avant de répéter l'étape 4. Si vous sentez le gaz, suivez les instructions sur la couverture de ce manuel. Si les brûleurs ne s'allument toujours pas après que plusieurs tentatives, se rapportent aux instructions pour l'éclairage manuel.

5. Répétez l'étape 4 pour que chaque brûleur additionnel soit Lit.

## ÉCLAIRAGE MANUEL

**ATTENTION:** Attendez toujours cinq (5) minutes le gaz pour se dégager après que n'importe quelle tentative non réussie d'éclairage.

1. Suivez les étapes 1 à 3 (à gauche).
2. Insérez un allumeur brûlant de butane de long-baril, une allumette brûlante de long-tige, ou une allumette brûlante tenue par un support de prolongation de fil par la grille à cuire s'ouvrant au brûleur (fig. 20-2). Tenez la flamme contre le bord du brûleur.
3. Tout en tenant l'allumette ou la flamme plus légère à côté du brûleur, diminuez le bouton de commande et tout en pressant le tour il dans le sens contraire des aiguilles d'une montre dans la position LÉGÈRE de HI. Enlevez l'allumeur ou assortissez quand le brûleur s'allume, et libérez le bouton de commande.
4. Si le brûleur ne s'allume pas, enfoncez immédiatement le bouton et tournez la valve à AU LOIN. ATTENDEZ CINQ (5) MINUTES avant de répéter les étapes 2 à 4 des instructions manuelles d'éclairage.

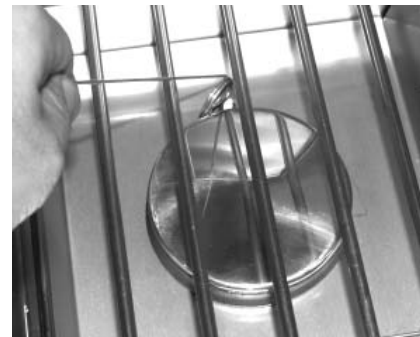

Fig. 20-2 - Éclairage manuel

## ARRÊT DU UNITÉ

Pour couper le unité, diminuez chaque bouton de commande de valve et tout en pressant tour il dans le sens des aiguilles d'une montre à la position de repos.

Fermez toujours la valve de la fourniture de gaz après chaque utilisation du unité.

### EN EMPLOYANT UN RÉSERVOIR DE PROPANE PORTATIF

Des réservoirs de propane sont équipés d'un dispositif d'arrêt de sûreté qui peut ne pas causer le bas ou aucunes pression de gaz/flamme aux brûleurs si le fonctionnement et l'allumage des instructions ne sont pas suivis exactement (voir la note importante dans la section de dépannage pour plus de détails.)

**Pour votre convenance et sûreté ; quand le bouton de commande est dans la position de fonctionnement, l'indicateur d'écoulement de gaz changera de bleu en le rouge. (Le rouge indique l'écoulement de gaz.) Voir la Fig. 20-1.**



# LIGHTING (IGNITION) INSTRUCTIONS

Read all instructions before lighting, and follow these instructions each time you light the unit.

## ELECTRONIC LIGHTING

**Note:** This unit must be connected to 120VAC power for electronic lighting.

1. Open lid(s) or remove cover(s) from burner(s) to be lit.
2. Turn all gas control knob(s) to their **OFF** position(s).
3. Turn on the gas at its source.

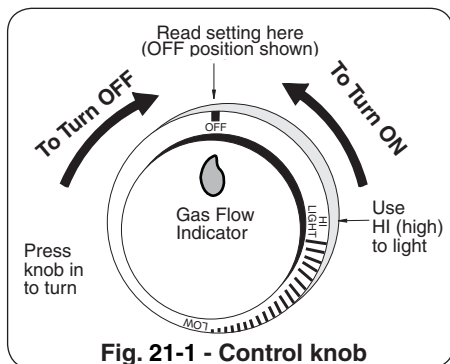

Fig. 21-1 - Control knob

**Note:** DO NOT turn on more than one valve at a time for either electronic or manual lighting.

4. Depress the desired control knob **for 5 seconds**, then, while pressing turn it counterclockwise to the **HI LIGHT** position. Once the burner lights, release the knob.

**CAUTION:** If a burner does not light within five (5) *seconds* of turning on the control knob, depress the knob and turn it to the **OFF** position. **WAIT FIVE (5) MINUTES** before repeating step 4. If you smell gas, follow the instructions on the cover of this manual. If the burners still do not light after several attempts, refer to the instructions for manual lighting.

5. Repeat step 4 for each additional burner to be lit.

## WHEN USING A PORTABLE PROPANE TANK

Propane tanks are equipped with a safety shutdown device that may cause low or no gas pressure/flame at the burners if operating and lighting instructions are not followed exactly (See important note in the TROUBLESHOOTING section for more details.)

## MANUAL LIGHTING

**CAUTION:** Always wait five (5) minutes for gas to clear after any unsuccessful lighting attempt.

1. Follow steps 1 through 3 (left).
2. Insert either a burning long-barrel butane lighter, a burning long-stem match, or a burning match held by a wire extension holder through the cooking grid opening to the burner (Fig. 21-2). Hold the flame against the edge of the burner.
3. While holding the match or lighter flame next to the burner, depress the control knob and while pressing turn it counterclockwise to the **HI LIGHT** position. Remove the lighter or match when the burner lights, and release the control knob.
4. If the burner does not light, **immediately depress the knob and turn the valve to OFF. WAIT FIVE (5) MINUTES** before repeating steps 2 through 4 of the **MANUAL LIGHTING** instructions.

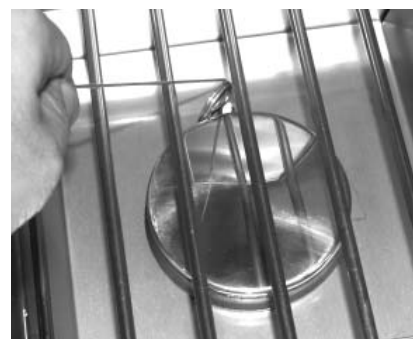

Fig. 21-2 - Manual lighting

## SHUTTING OFF THE UNIT

To shut off the unit, depress each valve control knob and while pressing turn it clockwise to the **OFF** position.

Always close the valve from the gas supply after each use of the unit.

**For your convenience and safety; when the control knob is in the on position, the gas flow indicator will change from blue to red. (Red indicates gas flow.) See Fig. 21-1.**

## CARE & CLEANING

APPLIANCE MUST BE COMPLETELY COOL WHEN CLEANING. DO NOT SPRAY ANY CLEANER OR LIQUIDS ON THE APPLIANCE WHEN HOT.

The appliance *must* be cleaned as often as once a month (depending on use) to prevent grease build-up and other food deposits.

### INTERIOR

THE **BURNER PORTS** MUST BE KEPT CLEAN TO ENSURE PROPER IGNITION AND OPERATION.

Remove the burner (see orifice changing instructions) and clean the ports and slots as required. Also inspect and clean the burner inlet for insects and nests. A clogged burner can lead to a fire in the bottom of the appliance.

The inside of the appliance may be cleaned periodically with oven cleaner if desired. Follow the oven cleaner instructions for proper use.

Be careful not to get oven cleaner on the outside surface of the appliance as it can permanently damage the finish.

### EXTERIOR

Stainless steel surfaces when exposed to temperatures produced by the grilling process will change color. The stainless steel will change color from silver to brown and blue. This can be removed by using stainless steel cleaner.

Clean your appliance by first using grill cleaner to remove grease and dirt. Always wipe with the grain (See Fig. 22-1). Next, use stainless steel cleaner to restore the stainless steel color (*Note: not for mirror finish*). Finish by wiping your appliance down using polish wipes. **To clean any mirror finish (if applicable), use a quality brand glass cleaner only, not any of the cleaners mentioned above.**

If your appliance is installed in a seaside (salt air) or poolside (chlorine) location, it will be more susceptible to corrosion and must be maintained/cleaned more frequently. Do not store chemicals (such as chlorine or fertilizer) near your stainless steel appliance.

Due to the nature of stainless steel, surface iron oxide deposits may appear. Do not be alarmed – these deposits are removable with stainless steel cleaner through prompt and periodic maintenance. If not attended to promptly, permanent pitting may occur.

By following these recommendations, you will enjoy the beauty and convenience of your appliance for many years to come.



Fig. 22-1 - Wipe with grain

### PROTECTING YOUR APPLIANCE FROM THE WEATHER

An optional cover will protect your appliance when not in use. (Allow to cool before covering.)

Please specify the model number and serial number of your appliance when ordering a cover.

### IMPORTANT

**IN THE EVENT OF A GREASE FIRE, IMMEDIATELY SHUT OFF THE MAIN GAS VALVE TO THE UNIT. KEEP THE LID OPEN AND ALLOW THE FIRE TO EXTINGUISH ITSELF. A THOROUGH INSPECTION BY A TRAINED SERVICE TECHNICIAN SHOULD BE CONDUCTED BEFORE FUTURE USE OF YOUR UNIT. THE SERVICE TECHNICIAN WILL CHECK THE SYSTEM FOR GAS LEAKS AND WILL CHECK ALL ELECTRICAL WIRING FOR DAMAGE. ALL GAS LEAKS AND WIRING MUST BE REPAIRED PRIOR TO FUTURE USE.**

## CHECKING AND CONVERTING GAS TYPE

This unit comes from the factory configured for one type of gas, as marked on the label located behind the control panel, or on the interior of the unit's enclosure.

**A certified kit is available from the manufacturer to convert your appliance from natural gas to L.P. or vice versa. Contact your dealer for ordering information. The professional installer must reference the steps below for conversion information. If the conversion kit ordered includes instructions, follow those instructions.**

1. Change brass gas orifices (included at original shipping) on each burner to match the new gas type (see MODEL SPECIFICATIONS TABLE, Table 1).
2. Switch the convertible gas regulator to match the new gas type (see section below).
3. Plumb the unit as appropriate for the new gas supply.
4. Apply the label for the new gas (included at original shipping) over the old gas information found on your unit.

### WARNING

**HAZARDOUS OVERHEATING WILL OCCUR IF A NATURAL-GAS ORIFICE IS USED WITH PROPANE GAS. IF YOU ARE NOT SURE IF THE CORRECT ORIFICES ARE INSTALLED, OR IF AN ORIFICE CHANGE IS NECESSARY, REFER TO THE FOLLOWING INSTRUCTIONS.**

**CAUTION:** Make sure the unit is at a safe temperature and isolated from gas and electrical supplies before beginning the tasks outlined below.

**Note:** The cooler the unit, the greater the tolerances between the stainless-steel parts, and therefore the easier to disassemble and reassemble parts of the unit.

**CAUTION:** For your safety, exercise caution and use adequate hand protection (such as gloves) when handling potentially sharp sheet-metal parts.

## CHECKING AND CONVERTING THE REGULATOR

Regulator: note cap on top

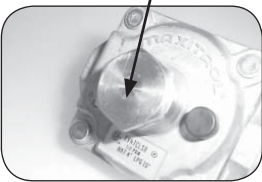

**Note:** Each end of the plastic converter is engraved with either the letters "NAT" or "L.P." (propane) for the respective gasses. When the converter is in the cap and the cap is held uppermost, the letters seen indicate the gas that the regulator is set up for.

To convert the regulator from one gas to another, follow steps 1-4.



**STEP 1:** Unscrew and remove the cap from the regulator, extracting the converter.



**STEP 3:** Turn the converter around and replace it carefully, into the center of the cap (it will snap into place). Check that you can read the type of gas the unit is set for.



**STEP 2:** Remove the converter (the plastic stalk) by carefully pulling it away from the center of the cap (it will snap out of its seating).

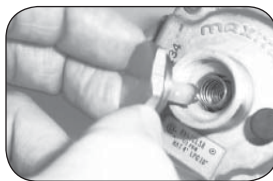

**STEP 4:** Replace the unit into the regulator and screw down until snug.

### WARNING

THIS APPLIANCE REGULATOR IS RATED FOR 1/2 PSI MAXIMUM. IF YOUR GAS SUPPLY IS GREATER THAN 1/2 PSI, AN ADDITIONAL REGULATOR MUST BE INSTALLED TO REDUCE THE INPUT PRESSURE TO THE UNIT TO 1/2 PSI OR LESS. SEE GAS-SUPPLY REQUIREMENTS SECTION FOR PROPER GAS-SUPPLY PRESSURE.

## CONTROL PANEL REMOVAL

### To remove the control panel:

1. Turn the control knobs to the OFF position and turn off the gas supply to the unit.
2. Turn off the light switch and disconnect the power supply from the power source.
3. Pull the control knobs from the stems and set aside.
4. Slowly lift away the lighted bezels to clear the valve stems, and carefully disconnect the wires found on the back of the bezels (use your fingernail). See Fig. 24-1.
5. Using a Phillips screwdriver, unscrew and remove the control panel fastener screws and washers (located on the left and right front face of the control panel). Retain the screws for later re-installation.
6. Carefully open the control panel by lifting and pulling the control panel from the frame.

**Important:** When opening, take caution to not damage any wiring.

7. If wire disconnections are required, reference the wire diagram in the MODEL SPECIFICATIONS section in this instruction manual or the wire diagram label affixed to the inside of the control panel.

**Note:** Secure any disconnected wires (coming from the inside of the unit) to prevent them from falling in.

**Note:** Whenever reconnecting any wires, apply a small amount of dielectric grease to the male connector, then make the connection.

**Important:** During reinstallation; prior to opening the gas shutoff valve, be sure the control knobs are in the OFF position.

## TROUBLESHOOTING

If you have trouble with this Fire Magic® unit, please use this list to identify the problem. By trying one or more of the solutions to the possible cause, you should be able to solve the problem. If this list does not cover your present problem, or if you have other technical difficulties with the unit, please contact your local Fire Magic® dealer or visit our web site at [www.rhpeterson.com](http://www.rhpeterson.com).

PROBLEM	POSSIBLE CAUSE	CORRECTION
<b>No power to unit</b>	<ol style="list-style-type: none"> <li>1. Power source not hooked to power supply</li> <li>2. Light switch is off</li> <li>3. Input power source failure</li> <li>4. Power supply failure</li> </ol>	<ol style="list-style-type: none"> <li>1. Hook external power to unit.</li> <li>2. Turn light switch on.</li> <li>3. Check GFCI / circuit breaker.</li> <li>4. Contact dealer for replacement.</li> </ol>
<b>Ignition system failure</b>	<ol style="list-style-type: none"> <li>1. Power source not hooked to power supply</li> <li>2. Ignition wire disconnected</li> <li>3. Low gas pressure</li> <li>4. Blown fuse in power supply box</li> <li>5. Igniter malfunction</li> <li>6. Igniter switch malfunction on valve</li> <li>7. Improper air shutter adjustment</li> </ol>	<ol style="list-style-type: none"> <li>1. Hook external power to unit.</li> <li>2. Plug wires back into wire harness.</li> <li>3. Have the gas co. check pressure at unit.</li> <li>4. Replace the fuse. Reference the POWER SUPPLY FUSE REPLACEMENT section.</li> <li>5. Contact dealer for replacement.</li> <li>6. Contact dealer for replacement.</li> <li>7. Adjust air shutters.</li> </ol>
<b>Insufficient heat / low flame</b>	<ol style="list-style-type: none"> <li>1. Using propane orifice for natural gas</li> <li>2. Low gas pressure/flame (propane)</li> <li>3. Low gas pressure/flame (natural)</li> <li>4. L.P. regulator hose cracked due to age</li> <li>5. Improper air shutter adjustment</li> </ol>	<ol style="list-style-type: none"> <li>1. Check/change orifices.</li> <li>2. Shut off all valves, including propane tank, and follow lighting instructions exactly. (See important note* below.)</li> <li>3. Have the gas co. check pressure at unit.</li> <li>4. Replace L.P. regulator hose.</li> <li>5. Adjust air shutters.</li> </ol>
<b>Uneven heating</b>	<ol style="list-style-type: none"> <li>1. Burner ports partially blocked by debris</li> <li>2. Small spiders or insects in burner</li> <li>3. Improper air shutter adjustment</li> </ol>	<ol style="list-style-type: none"> <li>1. Remove burners and clean out ports.</li> <li>2. Inspect burners and orifices for spider webs or other debris that may block flow.</li> <li>3. Adjust air shutter.</li> </ol>
<b>Knob light(s) not operating</b>	<ol style="list-style-type: none"> <li>1. Light switch off</li> <li>2. Knob light(s) burned out</li> </ol>	<ol style="list-style-type: none"> <li>1. Turn light switch on.</li> <li>2. Contact dealer for replacement.</li> </ol>
<b>Burner goes out on LOW</b>	<ol style="list-style-type: none"> <li>1. Valve "Low" setting needs adjustment</li> </ol>	<ol style="list-style-type: none"> <li>1. Light burner on HIGH, immediately turn to LOW setting. Remove knob from valve and using a small flat screwdriver, slowly turn the adjustment screw in the stem, a little at a time (30° to 45°), in either direction, until the flame is approximately 1/4" in height from burner ports.</li> </ol>

**\* Important:** Propane tanks are equipped with a safety shutdown device that may cause low or no gas/flame at the burners if operating and lighting instructions are not followed exactly. If you suspect the propane tank safety shutoff is in effect, shut off all burner control valves and the propane tank valve. Then read and follow the LIGHTING INSTRUCTIONS exactly. Lighting instructions are located in your owner's manual and printed on the front face of the unit. If the problem persists, continue troubleshooting, or contact your local dealer or R. H. Peterson for assistance.



# WARRANTY

## PETERSON FIRE MAGIC GRILLS AND ACCESSORIES LIMITED WARRANTY

Robert H. Peterson Co. ("RHP") warrants your Fire Magic® grill to be free from defects in material and workmanship.

Fire Magic® cast stainless-steel burners, stainless-steel rod cooking grids, and stainless-steel housings are warranted for as long as you own your Fire Magic® grill -- **LIFETIME**. (Except as noted below.)

Fire Magic Choice stainless steel tubular burners are warranted for **TWENTY (20) YEARS**.

Fire Magic® cast brass burners, brass valves, inner liners, manifold assemblies, and backburner assemblies (except ignition parts) are warranted for **FIFTEEN (15) YEARS**.

Fire Magic® Electric Grills, including stainless steel grid, and housings are warranted for **TEN (10) YEARS**.

Fire Magic® Infra-red burners, flavor grids, Charcoal stainless steel grills, and Smokers are warranted for **FIVE (5) YEARS**; except for the charcoal pan, charcoal grid, wood pellet screen, thermometer, and ash tray; which are warranted for **ONE (1) YEAR**.

Fire Magic® sideburners and all other Fire Magic® grill components (except ignition and electronic parts) are warranted for **THREE (3) YEARS**.

Fire Magic® ignition systems (excluding batteries), electronic components (including lights and thermometers), and grill accessories are warranted for **ONE (1) YEAR**.

### A COPY OF YOUR SALES SLIP FOR PROOF OF PURCHASE IS REQUIRED

This warranty applies to the original purchaser for products which are installed in the United States or Canada and which are operated and maintained as intended for single family residential usage. This warranty is valid only with proof of purchase, shall commence on the date of purchase, and shall terminate (both as to original and any replacement products) on the anniversary date of the original purchase of the product stated on the above schedules.

This warranty covers defects in material and workmanship. This warranty **does not** cover parts which become defective as a result of negligence, misuse, use not in compliance with the Owner's Manual/Installation Instructions, accidental damage, improper handling, improper storage, improper installation, lack of required routine maintenance (as specified in the Owner's Manual/Installation Instructions), electrical damage, local gas impurities or failure to protect against combustibles. Product must be installed (and gas must be connected) as specified in the Owner's Manual/Installation Instructions by a **qualified professional installer**. Modifications to products which are not specifically authorized will void this warranty. Accessories, parts, valves, remotes, etc. when used must be Peterson products or this warranty is void. Warrantied items will be repaired or replaced at Peterson's sole discretion. This warranty **does not** apply to rust, corrosion, oxidation, or discoloration unless the affected part becomes inoperable.

This warranty **does not** cover labor or labor related charges, except as provided by separate specific written programs from the Peterson Co. All repair work must be performed by a qualified professional service person and requires prior approval of Peterson.

Peterson may require the defective product or part to be returned to the factory to determine the cause of failure. Peterson will pay freight charges if the product or part is determined to be defective. This warranty does not cover breakage in shipment from our (Independent) distributor to its customer if the damage is determined to have occurred during that shipment.

This warranty specifically excludes liability for **indirect, incidental, or consequential** damages. Some states and provinces do not allow the exclusion or limitation of incidental or consequential damages, so the above exclusion may not apply to you. This warranty gives you specified legal rights, and you may have other rights that vary from state to state or province.

For additional information regarding this warranty, or to place a warranty claim, contact the R. H. Peterson dealer where the product was purchased.

**TO REGISTER YOUR PRODUCT ONLINE GO TO: [WWW.RHPETERSON.COM](http://WWW.RHPETERSON.COM),  
AND CLICK ON PRODUCT REGISTRATION. THANK YOU FOR YOUR PURCHASE.**

<b>Quality Check</b>			<b>Date:</b> _____		
<b>Burner Orifices</b>	Nat.	L.P.	<b>Leak Test:</b> _____	<b>Model#:</b> _____	
<b>Main:</b>	_____	_____	<b>Burn Test:</b> _____	<b>Serial#:</b> _____	
<b>Other:</b>	_____	_____	<b>Gas Type:</b> <u>Nat. / L.P.</u>	<b>Air Shutter:</b> _____	
				<b>Inspector:</b> _____	